

Keysight Technologies

Specifying Calibration Standards
and Kits for Keysight Vector
Network Analyzers

Application Note



Unlocking Measurement Insights



Introduction

Measurement errors in network analysis can be separated into two categories: random and systematic errors. Both random and systematic errors are vector quantities. Random errors are non-repeatable measurement variations and are usually unpredictable. Systematic errors are repeatable measurement variations in the test setup.

Measurement errors

Systematic errors include impedance mismatch, system frequency response and leakage signals in the test setup. In most microwave measurements, systematic errors are the most significant source of measurement uncertainty. The source of these errors can be attributed to the signal separation scheme used.

Numerous publications are available on vector network analyzer (VNA) calibration techniques. References [1], [2], [3], [4], [5], [6], [7] and [8] are just some of the published work. Keysight Technologies, Inc. application notes: 1287-1, 1287-2 and 1287-3 also provide insights on VNAs and VNA error correction. It is recommended that a user be familiar with these calibration techniques and terminologies to get the maximum understanding from this application note.

Measurement calibration

A measurement calibration is a process which mathematically derives the systematic error model for the VNA. This error model is an array of vector error coefficients used to establish a fixed reference plane of zero phase shift, zero reflection magnitude, lossless transmission magnitude and known impedance. The array of coefficients is computed by measuring a set of “known” devices or calibration standards connected at a fixed measurement plane.

Different calibration techniques are used to solve different error models. The definition of calibration standards and types are set up differently for the applicable calibration techniques. Solving the full 2-port twelve term error model using the short/open/ load/thru (SOLT) calibration method is an example of only one of the many measurement calibrations available.

The type of measurement calibration selected by the user depends on the device to be measured (i.e., 1-port or 2-port device) the calibration standards available and the extent of accuracy enhancement desired. A combination of calibrations can be used in the measurement of a particular device, such as adapter removal calibration for non-insertable devices. The accuracy of subsequent device measurements depends on the accuracy and stability of the test equipment, the accuracy of the calibration standard model, and the calibration method used in conjunction with the error correction model.

This application note covers calibration standard definitions, calibration kit content and its structure requirements for Keysight’s vector network analyzers. It also provides some examples of how to set up a new calibration kit and how to modify an existing calibration kit definition file.

Calibration Kits

A mechanical calibration kit consists of a set of physical devices called standards, as shown in Figure 1. Each standard has a precisely known magnitude and phase response as a function of frequency. In order for the VNA to use the standards of a calibration kit, each standard must be “assigned” or organized into standard classes which correspond to the calibration method used by the VNA. Keysight currently supplies mechanical calibration kits with 1.0-mm, 1.85-mm, 2.4-mm, 3.5-mm, 7-mm, and Type-N 50 ohm, Type-N 75 ohm, Type-FD 75 ohm and 7-16 coaxial connectors. Rectangular waveguide calibration kits include X, P, K, R, Q, U, V and W bands. Calibration for microstrip and other non-coaxial media is described in Product Note 8510-8A: Keysight Network Analysis Applying the 8510 TRL Calibration for Non-Coaxial Measurements, literature number 5091-3645E. A calibration kit may support many calibration methods.



Figure 1. Mechanical cal standards and cal kit

Connector definitions

In addition to calibration standard definitions and standard class assignments, calibration kits also provide definitions of connectors. Keysight's PNA network analyzer family uses the connector definition to define connector (Figure 2):

- Frequency Range
- Gender (male, female, no gender)
- Impedance
- Media (coax, waveguide, etc)
- Cutoff Frequency (waveguide)
- Height/Width Ratio (waveguide)

Add or Edit Connector

Identification

Connector Family X-band waveguide

Description X-band waveguide

Frequency Range

Min 6555 MHz

Max 13111 MHz

Gender

Male

Female

No Gender

Impedance

Z0 1 ohms

Media

WAVEGUIDE

Cutoff Frequency 6555 MHz

Height/Width Ratio 0.5

OK Cancel Apply Help

Figure 2. PNA connector entry screen

A calibration kit may be defined with multiple connectors. Each 1-port calibration standard must be associated with a defined connector. Two port standards, such as thru and adapters, may be associated with two different defined connectors.

Calibration standards definition

The S-parameters of VNA calibration standards must be defined sufficiently and accurately to satisfy the requirements of the calibration methods for which they will be used. Calibration standards may be defined in various ways. Keysight’s VNAs support two types of calibration standard definitions: calibration coefficient model and data-based model.

Calibration coefficient model

The majority of VNAs define calibration standards by using a transmission line model for 2-port standards and a terminated transmission line model for 1-port standards. (See Figure 3.)

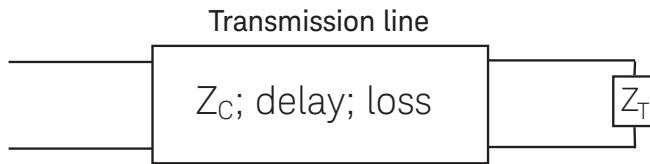

Figure 3. Terminated transmission line model

The transmission line and termination may be represented by a signal flow graph as illustrated in Figure 4.

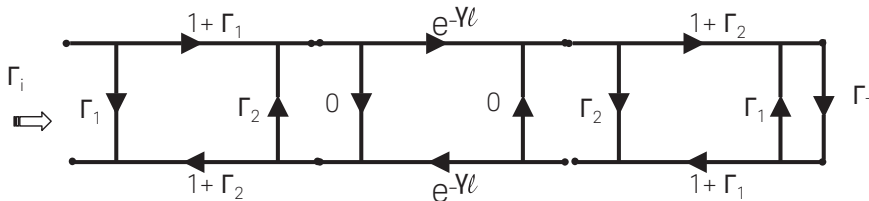

Figure 4 Signal flow graph of terminated transmission line model

Figure 5 shows the same terminated transmission line model in cascade parameter format; define XI and Xo

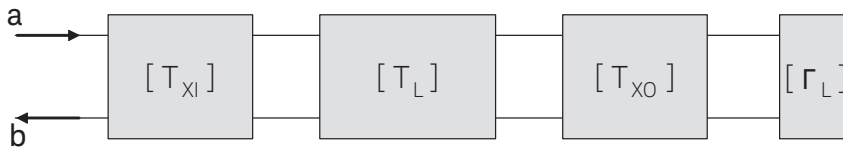

Figure 5. Cascade parameter representation of terminated transmission line model

Where

$$\Gamma_1 = \frac{Z_c - Z_r}{Z_c + Z_r}; \Gamma_2 = -\Gamma_1; \Gamma_T = \frac{Z_T - Z_r}{Z_T + Z_r} \tag{1.1}$$

$\gamma = \alpha + j\beta$; l = length of line;

$Z_c \equiv$ characteristic impedance of line

$Z_r \equiv$ reference impedance (connector impedance or system impedance)

$\alpha \equiv$ propagation loss constant of line

$\beta \equiv$ propagation phase constant of line

$$\Gamma_i = \frac{b}{a}; \begin{bmatrix} b \\ a \end{bmatrix} = [T_{xl}][T_L][T_{xo}][\Gamma_L] \quad (1.2)$$

$$[T_{xl}] = \left(\frac{-}{+\Gamma} \right) \begin{bmatrix} & \\ & \end{bmatrix}; [T_L] = \begin{bmatrix} e^{-\gamma} & 0 \\ 0 & e \end{bmatrix}$$

$$[T_{xo}] = \left(\frac{1}{1-\Gamma_1} \right) \begin{bmatrix} 1 & -\Gamma_1 \\ -\Gamma_1 & 1 \end{bmatrix}; [\Gamma_L] = \begin{bmatrix} \Gamma_T \\ 1 \end{bmatrix} \quad (1.3)$$

$$\Gamma_i = \frac{\Gamma_1(1 - e^{-2\gamma l} - \Gamma_1\Gamma_T) + e^{-2\gamma l}\Gamma_T}{1 - \Gamma_1[e^{-2\gamma l}\Gamma_1 + \Gamma_T(1 - e^{-2\gamma l})]} \quad (1.4)$$

Transmission line characteristic impedance and propagation constants can be derived from the line's physical properties [9], [10].

Keysight's VNA uses offset delay, offset loss and offset Z_0 instead of Z_C , and γl to model the transmission line. With these "offset" definitions, the VNA can compute the transmission line's characteristic impedance and, propagation phase and loss constants of the calibration standard without defining the dielectric constant of the calibration standard's transmission medium which may be different from that of the device under test. This assumes that the offset loss and offset delay values were derived using the same dielectric constant.

Offset delay

Offset delay is the dispersion free, TEM mode, electrical delay in seconds.

$$(\text{offset delay}) = \frac{l\sqrt{\epsilon_r}}{c}; \quad (1.5)$$

l = physical offset length from reference plane

ϵ_r = relative permittivity (dielectric constant) of transmission medium

= 1.000649 in air @ sea level and 50% humidity

c = speed of light in vacuum = 2.99792458×10^8 m/s

Note that the reference plane of coaxial connectors is defined as the mating plane of the outer conductors. "Appendix A" on page 30 illustrates the physical offset length definition of certain coaxial connector types.

Offset loss

Offset loss is in G½/sec. It is the propagation loss per unit length of the transmission line at a normalization frequency, such as 1 GHz, multiplied by the speed of light in the transmission medium. For coaxial devices, it can be calculated from the loss magnitude data at 1 GHz.

S21 data:

$$\begin{aligned} \text{Linear mag: (Offset loss)} &= -2 * \ln(|S_{21}|_{1\text{GHz}}) \left(\frac{\text{Offset } Z_0}{\text{Offset delay}} \right) \\ \text{Log mag (dB): (Offset loss)} &= \left(\frac{-\ln(10)\text{dB}_{1\text{GHz}}}{10} \right) \left(\frac{\text{Offset } Z_0}{\text{Offset delay}} \right) \end{aligned} \quad (1.6)$$

S11 data:

$$\begin{aligned} \text{Linear mag: (Offset loss)} &= -\ln(|S_{21}|_{1\text{GHz}}) \left(\frac{\text{Offset } Z_0}{\text{Offset delay}} \right) \\ \text{Log mag (dB): (Offset loss)} &= \left(\frac{-\ln(10)\text{dB}_{1\text{GHz}}}{20} \right) \left(\frac{\text{Offset } Z_0}{\text{Offset delay}} \right) \end{aligned} \quad (1.7)$$

For best results, curve fit the measured data to the $\sqrt{\frac{f}{10^9}}$ function. See “Appendix B” on page 32 for details.

For rectangular waveguide transmission lines, loss is not a simple function of frequency. In most cases, the 1 GHz data point is not available. Since the loss of most waveguide standards are very small and are usually used way above cut off, the offset loss term is assumed to be “0”. The waveguide loss model is not supported by all VNAs until recently.

Keysight’s PNA series of network analyzers now include a waveguide loss model. See “Appendix C” on page 35.

$$\text{(offset loss)} = \frac{-\ln(|S_{21}|_{@f})}{(\text{offset delay})} \left(\sqrt{\frac{\mu_0}{\epsilon_0}} \right) \sqrt{\frac{f_c}{f}} \left[\frac{\sqrt{1 - \left(\frac{f_c}{f}\right)^2}}{1 + \frac{2h}{w} \left(\frac{f_c}{f}\right)^2} \right] \quad (1.8)$$

Offset Z_0

Offset Z_0 is the lossless characteristic impedance of the transmission line. For coaxial transmission lines, the lossless characteristic impedance is

$$Z_0 = \left(\frac{1}{2\pi} \right) \sqrt{\frac{\mu}{\epsilon}} \ln\left(\frac{D}{d}\right) = \left(\frac{\mu_0 c}{2\pi} \right) \sqrt{\frac{\mu_r}{\epsilon_r}} \ln\left(\frac{D}{d}\right) \quad (1.9)$$

μ = relative permeability constant of the transmission medium

D = outer conductor inner diameter, d = center conductor outer diameter

Z_C , the transmission line characteristic impedance that includes skin loss effects can be derived from the offset Z_0 and offset loss terms.

Waveguide offset Z_0 and characteristic impedance is normalized to “1”.

Offset terms and transmission line parameters

For coaxial transmission lines the following expressions relate the offset terms to the transmission line's electrical parameters. See "Appendix B" on page 32 for their derivation.

$$\alpha l = \left[\frac{(\text{offset loss})(\text{offset delay})}{2(\text{offset } Z_0)} \right] \sqrt{\frac{f}{10^9}}; f \equiv \text{frequency in Hz}$$

$$\beta l = 2\pi f(\text{offset delay}) + \alpha l$$

$$Z_c = (\text{offset } Z_0) + (1-j) \left(\frac{\text{offset loss}}{4\pi f} \right) \sqrt{\frac{f}{10^9}} \quad (1.10)$$

For rectangular waveguide transmission lines [11] the following expressions relate the offset terms to the transmission line's electrical parameters. See "Appendix C" on page 35 for details.

$$\beta l = 2\pi f(\text{offset delay}) \sqrt{1 - \left(\frac{f_c}{f} \right)^2}; \quad (1.11)$$

$f_c =$ waveguide cut off frequency

$$\alpha l \approx (\text{offset loss})(\text{offset delay}) \left(\sqrt{\frac{f}{f_c}} \right) \left(\sqrt{\frac{\epsilon_0}{\mu_0}} \right) \left[\frac{1 + \frac{2h}{w} \left(\frac{f_c}{f} \right)^2}{\sqrt{1 - \left(\frac{f_c}{f} \right)^2}} \right]$$

Waveguide impedance varies as a function of frequency. In such cases, normalized impedance measurements are typically made. When calibrating in waveguide, the impedance of a "matched" load is used as the impedance reference. The impedance of this load is matched to that of the waveguide characteristic impedance across the guide's frequency bandwidth. Normalized impedance is achieved by setting OFFSET Z_0 to 1 ohm for each standard and setting system Z_0 (SET Z_0) to 1 ohm.

Terminating devices

Short

Many vector network analyzers assume that the short is an ideal short and has a reflection coefficient of -1 . This may be adequate at low frequencies and for large connector sizes, such as 7 mm and larger. However, at higher frequencies and for smaller connectors, 3.5 mm and smaller, at least a third order polynomial inductance model, L_s , is required. Loss of the short circuit is assumed to be insignificant.

$$L_s = L_0 + L_1 f + L_2 f^2 + L_3 f^3; Z_s = j2\pi f L_s$$

$$\Gamma_s = \frac{Z_s - Z_r}{Z_s + Z_r} \quad (1.12)$$

In some cases (when the phase response is linear with respect to frequency) the response of a short can be modeled as an equivalent “incremental” length.

$$C_0 = C_0 + C_1 f + C_2 f^2 + C_3 f^3; Z_0 = \frac{1}{j2\pi f C_0}$$

$$\Gamma_0 = \frac{Z_0 - Z_r}{Z_0 + Z_r} \quad (1.13)$$

Open

Open circuits radiate at high frequencies. This effectively increases the electrical length of the device and can be modeled as a frequency dependent capacitor, C_0 , (also known as fringing capacitance). At low frequencies, a fixed capacitance value may be sufficient. Most network analyzers use a third order polynomial capacitance model. Radiation loss is assumed to be insignificant.

In some cases (when the phase response is linear with respect to frequency) the response of an open can be modeled as an equivalent “incremental” length.

Fixed load

The fixed load is assumed to be a perfect termination, $\Gamma_L = 0$. However, if an offset transmission line with a finite delay and loss is specified, and an offset Z_0 is not equal to the reference impedance, the total reflection is NOT zero. This is as defined in equation (1.4).

Arbitrary impedance

An arbitrary impedance device is similar to a fixed load except that the load impedance is NOT perfect. The previous generations of VNA, such as the Keysight 8510, 87xy series and the early firmware releases of the PNA series, use a fixed resistance value. A complex terminating impedance has been added to the PNA series to allow for more accurate modeling of circuit board and on-wafer devices.

$$Z_A = R + jI; \Gamma_A = \frac{Z_A - Z_r}{Z_A + Z_r} \quad (1.14)$$

Offset loads

Figure 6. PNA offset load entry screen

Note

The 8510 assumes that the first offset has zero delay and the second offset has the required delay. Therefore, the offset delay value of the offset load must be the difference in delay between the two offsets.

An offset load can be considered a compound standard consisting of 2 known offsets (transmission lines) of different length and a load element (Figure 6). The definition of the offsets is the same as all offset transmission lines. The shorter of the two offsets can be a zero length offset. The load element is defined as a one-port reflection standard. An offset load standard is used when the response of the offset standards is known more precisely than the response of the load element. Measurement of an offset load standard consists of two measurements, one with each offset terminated by the load element. The frequency range of the offset load standard should be set so that there will be at least a 20-degree separation between the expected response of each measurement. In cases where more than two offsets are used the frequency range may be extended as the internal algorithm at each frequency will search through all of the possible combinations of offsets to find the pair with the widest expected separation (to use in determining the actual response of the load element.) When specifying more than two offsets, the user should define multiple offset load standards.

When assigning multiple offset load standards to SOLT classes for the PNA, it is usually beneficial to specify “use expanded math when possible”. See the section on “SOLT class assignment” on page 16.

Sliding load

A sliding load is defined by making multiple measurements of the device with the sliding load element positioned at various marked positions of a long transmission line. The transmission line is assumed to have zero reflections and the load element has a finite reflection that can be mathematically removed, using a least-squares-circle-fitting method. For best results, try to move the load element in the same direction, do not move it back and forth. Also, try to slide in non-uniform, not equally spaced, increments.

Data-based standard model

The data-based standard model is a new feature in Keysight's network analyzers. It allows a calibration standard to be defined by a data file that contains frequency data, S-parameter data and uncertainty data. The data file may be created using actual measured data from a reference metrology laboratory, model data from device modeling software or combinations of both. See Appendix D on page 37 for details on data file formats.

Figure 7 shows how the data-based standard bypasses the fitting process and eliminates any errors that may have been associated with the fitting. Fitting errors are usually negligible for frequencies below 30 GHz. However, at higher frequencies multiple frequency banded models for the same standard have been used to avoid errors due to fitting. The data-based standard avoids this problem altogether by interpolating on the data directly. The data-based calibration standard also eliminates shortcomings of fitting non-coaxial or waveguide standards to the models based on a coaxial or waveguide structure. This increased flexibility also enables the user to more easily define custom calibration standards that do not accurately fit existing calibration coefficient models. This can be especially useful for dispersive transmission line structures. The data may be obtained by device modeling based on physical dimensions or from accurate measurements.

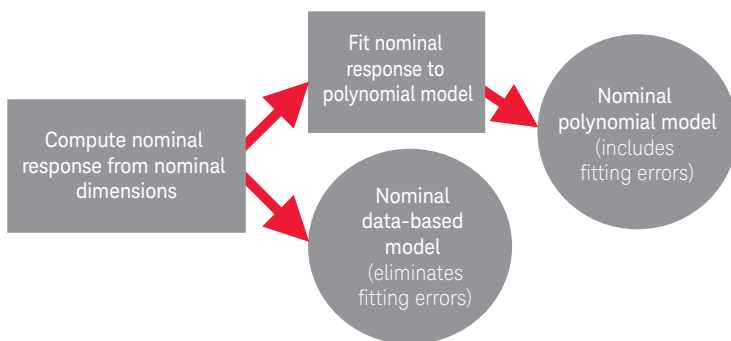

Figure 7. Data-based vs. polynomial model

The factory data-based models are similar to polynomial models in that they are a generic nominal model for a particular part number. Thus, a replacement calibration standard can be ordered for a calibration kit and used without having to modify the data-based model.

Data-based standards also open the opportunity of enhancing the accuracy of a particular calibration kit. For example, calibration with a broadband load calibration kit is usually less accurate than calibration with either a TRL calibration kit or sliding load calibration kit. The main source of degradation is the accuracy of the fixed load model. The generic model for a fixed load is that its reflection coefficient is equal to zero at all frequencies. As an alternative, a fixed load can be characterized using a more accurate calibration. The resulting characterization data, with uncertainties, is used as the data-based standard definition of that particular load. Figure 8 shows how the data files can be created. Figure 9 shows the data entry screen for data-based standards. Calibrations using the fixed load and its associated data-based model will have an accuracy approaching the accuracy of the system that characterized the fixed load. The residual directivity error now depends on the uncertainty of the characterization rather than the specification of the load.

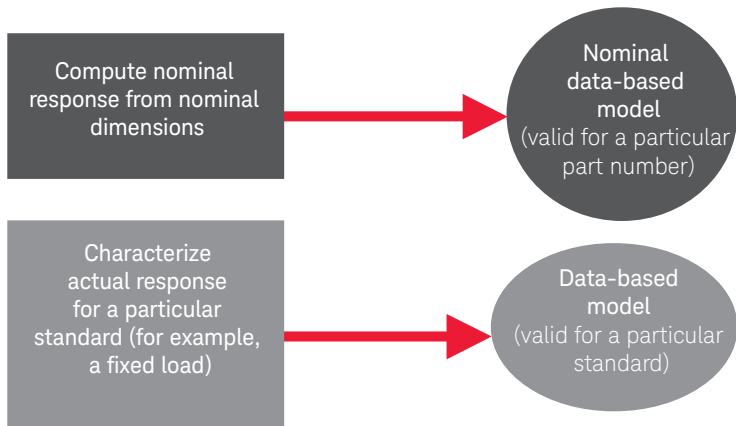

Figure 8. Nominal vs. customized data-based file

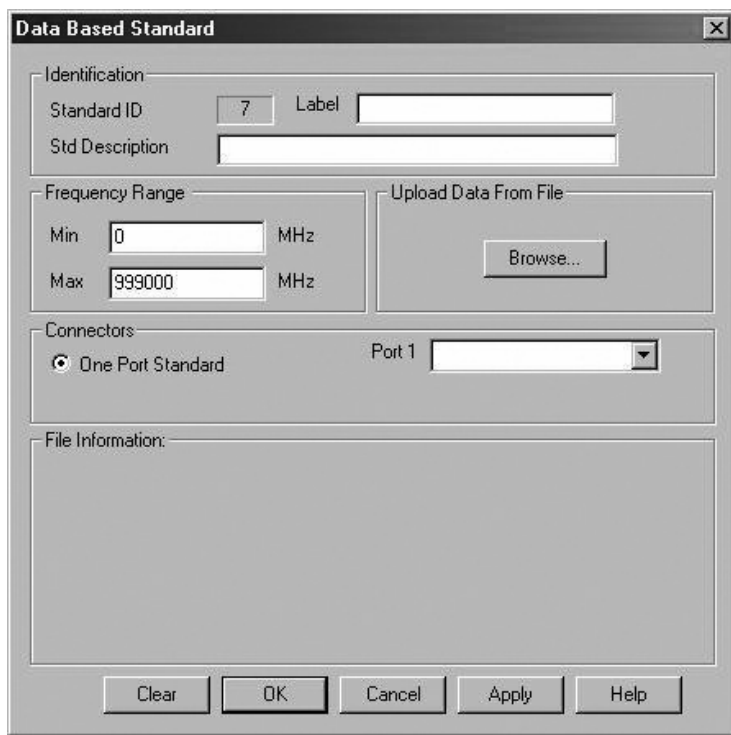

Figure 9. Data-based standard setup screen

Maximum/minimum frequency

The maximum and minimum frequency entries define the applicable frequency range of the calibration standard. The applicable range may be limited by the model data, accuracy of the model or the physical dimensions of the calibration standard. A fixed load, for example, may be used at low frequencies while a sliding load may be used at high frequencies.

For waveguide, the minimum frequency is the waveguide cut-off frequency. Although the PNA's SmartCal (guided cal) no longer uses the minimum frequency of a calibration standard as the cut-off frequency for dispersion correction, it is still recommended that the minimum frequency equals the cut-off frequency for backward compatibility.

Class assignment

Calibration kit class assignment organizes calibration standards into a format which is compatible with the error models used in measurement calibration. Each calibration standard is assigned with a standard number. That number is then assigned to a class or calibration measurement that is required for the calibration method selected. Some standards may have multiple standard numbers assigned for different calibration methods or different standard definitions. This may be necessary to optimize the accuracy of the standard model for a given frequency band and/or calibration requirement.

For the 8510 VNA, a calibration kit may contain up to 21 standards. There is no limit on the PNA SmartCal (guided cal). The required number of standards will depend on frequency coverage and calibration methods supported.

A single standard class is a standard or group of (up to 7 for most VNA) standards that comprise a single calibration step. The standards within a single class are assigned to locations A through G as listed in the Class Assignments table. It is important to note that each and every class must be defined over the entire frequency range for which the calibration is made, even though several separate standards may be required to cover the full measurement frequency range.

Not all VNAs support the same set of calibration methods and calibration kits. Check the instrument's documentation for its capabilities. The following sections provide detailed descriptions of the various VNA class assignment structures.

VNA calibrations are test-port specific and therefore class assignments are structured around port numbers. Since only 1-port and 2-port calibration standards are available, calibration kit class assignments are 2-port based, only one port pair can be calibrated at a time.

Standard types

Calibration standards are assigned to the following standard types (Figure 10):

OPEN, SHORT, LOAD, THRU, ADAPTER (8510) and DATA BASED STANDARD (PNA)

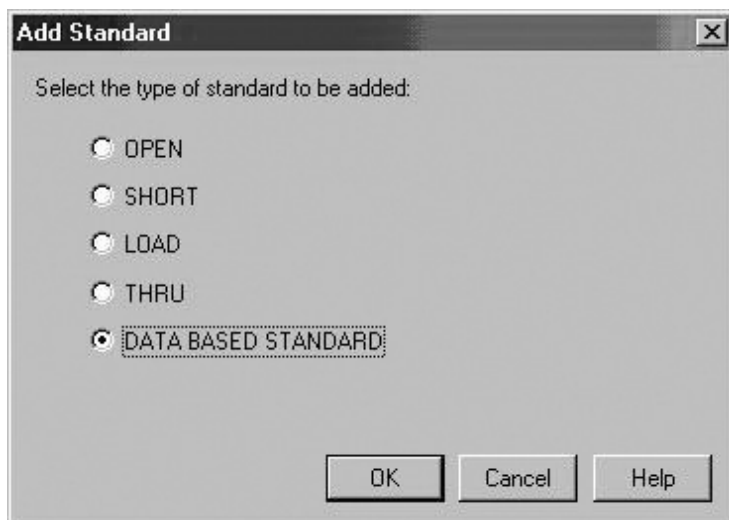

Figure 10. Calibration standard selections

An OPEN calibration standard assumes that the polynomial coefficients represent a capacitance model and computes its reflection coefficients according to equation (1.13). The VNA assumes that each capacitance coefficient is scaled to a default exponent.

$$\begin{aligned} C0 &= \text{sxx.xxx}10^{-15}\text{F}; C2=\text{sxx.xxx}10^{-36}\text{F/Hz}^2; s=\text{sign(+or -)} \\ C1 &= \text{sxx.xxx}10^{-27}\text{F/Hz}; C3=\text{sxx.xxxx}10^{-45}\text{F/Hz}^3 \end{aligned} \quad (1.15)$$

All Keysight VNA models use the same scaling factor.

A SHORT calibration standard assumes that the polynomial coefficients represent an inductance model and computes its reflection coefficients according to equation (1.12). The default exponents for inductance terms are:

$$\begin{aligned} L0 &= \text{sxx.xxx}10^{-12}\text{H}; L2=\text{sxx.xxx}10^{-33}\text{H/Hz}^2; s=\text{sign(+or -)} \\ L1 &= \text{sxx.xxx}10^{-24}\text{H/Hz}; L3=\text{sxx.xxxx}10^{-42}\text{H/Hz}^3 \end{aligned} \quad (1.16)$$

Four types of LOAD standards are available: a fixed load, sliding load, arbitrary impedance and offset load. The default setting for fixed load is delay=0, loss=0 and Z0=50 ohms; a perfect termination. A sliding load triggers prompts for multiple slide positioning and measurements. A minimum of 6 slide positions is recommended. Arbitrary impedance requires a terminating impedance entry, a real value only for most VNA and complex value for the PNA. Offset load requirements are explained in the “Terminating Device” section on page 10.

A DATA BASED STANDARD is defined by a data file. See “Appendix D” on page 37 for the requirements and format of data files.

Calibrations and class assignments

Assigning standards to class

Calibration kits can be created to support SOLT calibrations, TRL calibrations, or both. Class assignments are a way for the calibration kit file to guide the selection of standards during the calibration process.

When assigning standards to a class for the PNA SmartCal (guided cal) the order in which the standards appear indicates the default preference for the calibration kit. As the internal PNA firmware searches for the appropriate calibration standard to use at a given frequency it starts at the top of the list and searches until it finds a standard that can be used at that frequency. For this reason it is important to list the preferred standards first. For example, a calibration kit that includes a sliding load usually also includes a broadband load—if the broadband load is listed before the sliding load, the sliding load will not come up as a default selection.

For the 8510 and its derivatives (87xy and unguided cal of the PNA), the order of standard assignment within a given class is not important. The order of the standard measurements is important. When two standards have overlapping frequency bands, the last standard to be measured will be used. The order of standard measurement between different classes is not restricted, although the 8510 requires that all standards that will be used within a given class are measured before proceeding to the next class.

Multiport calibrations use a series of one-port and two-port calibration standards and are comprised of a series of two-port SOLT and /or TRL calibrations.

SOLT class assignment

In the simplest case, an SOLT calibration consists of two one-port calibrations followed by forward and reverse transmission and reflection measurements on a thru standard. The thru standard can be a defined thru or an “unknown thru”. The simplest thru standard is a zero-length thru which is simply the connection of port i to port j. Selecting the radio button corresponding to a particular class enables modification of both the standards included in the class, and a user-defined label associated with the class. The user-defined class label is visible during unguided calibration on the PNA.

Each one-port calibration requires reflection measurements on at least three known and distinct standards. S11A, S11B, and S11C represent the three reflection standard classes for port i while S22A, S22B, and S22C represent the three reflection standard classes for port j. Most of the time S11A and S22A have the same standards, S11B and S22B have the same standards, and S11C and S22C have the same standards. The standards assigned to each class may have different connector definitions, different frequency coverage, and different standard types. Some calibration kits, such as the Keysight 85059A 1.0 mm precision calibration kit, use a combination of open, short, load and offset short standards to calibrate over a very wide frequency range. Both shorts and opens are assigned to the S11A class as illustrated by Figure 11. Label is just a name assigned to that class. This label is used for on-screen prompts or softkey labels during the calibration measurement process.

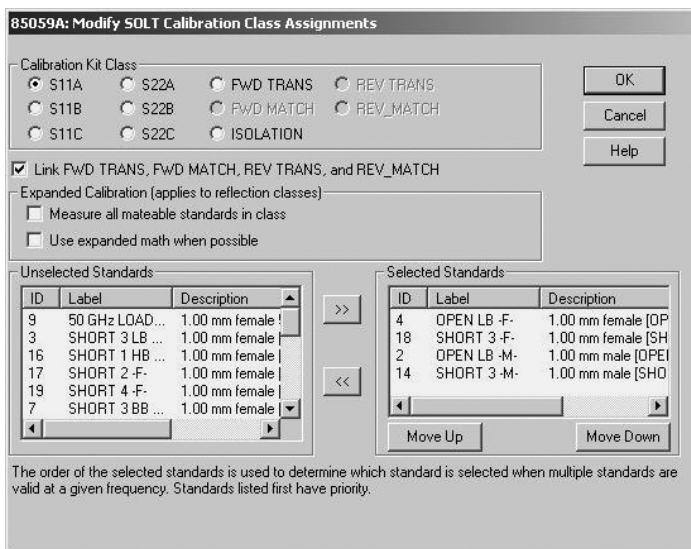

Figure 11. Example – opens and shorts in the same class

Four calibration classes are associated with the thru standard measurements, namely: FWD TRANS, FWD MATCH, REV TRANS, and REV MATCH. Except for rare occasions, these classes will all contain the same standards; the LINK FWD TRANS, FWD MATCH, REV TRANS, and REV MATCH checkbox facilitates the common manipulation for these classes.



Unchecking the “LINK” option provides the ability to define different standards for each of these classes. This option would be used in the rare case where an external testset may require manipulation between the various measurements of the thru standard. In this case assigning different standards for each class will result in a separate prompt during calibration. Normally, one thru standard would be assigned to the FWD TRANS and FWD MATCH classes and a different thru standard, with an identical model, would be assigned to the REV TRANS and REV MATCH classes. This would result in two separate prompts during the calibration sequence.

The unknown thru calibration is one of the thru choices of the PNA. It does not require a thru standard definition. Any two port passive reciprocal device can be used as the “unknown thru” device. A low-loss device, less than -20 dB loss, is preferred but not a requirement.

Adapter class is set up in the 8510 for adapter removal calibration. It defines the electrical delay of the adapter in order to determine the correct S11 and S22 response of the adapter. The delay value need not to be very accurate. However, the correct phase, within ± 90°, for all the measurement frequency points must be provided.

A class assignment table is a very useful tool to help organize calibration standard assignments for data entry. All calibration kit operating and service manuals provide examples and blank forms of assignment tables. Compare the SOLT class assignment table (Table 1) with the PNA’s cal kit editor SOLT class assignment edit screen (Figure 12) to see the mapping relationships. The SOLT class assignment table maps directly into the 8510’s modify cal kit class entry format.

Table 1. SOLT class assignment table for the 85052D kit

CLASS	A	B	C	D	E	F	G	Class Label
S11A	2	15						Open
S11B	1	7						Short
S11C	3	14						Load
S11A	2	15						Open
S22B	1	7						Short
S22C	3	14						Load
Forward transmission	4	4	4					Thru
Reverse transmission	4	4	4					Thru
Forward match	4	4	4					Thru
Reverse match	4	4	4					Thru
Adapter	15							Adapter

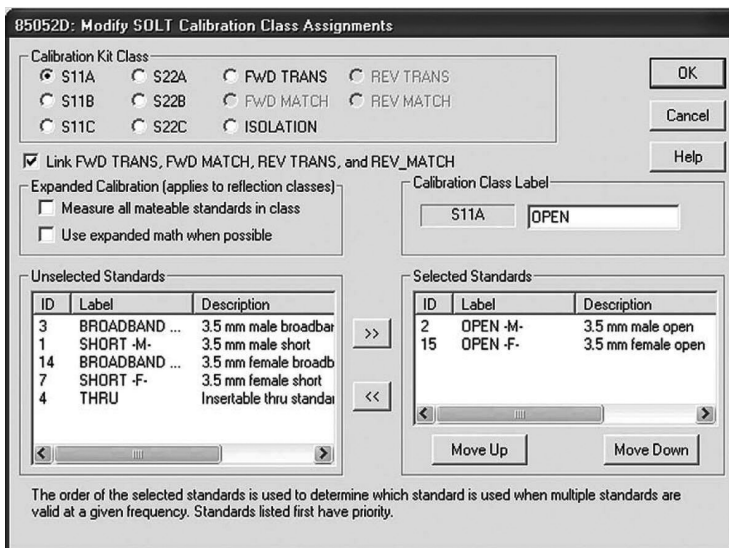

Figure 12: PNA’s cal kit editor modify SOLT class screen for 85052D kit

Traditionally, reflection calibrations have been computed using the measured response of three calibration standards at each frequency. For port *i*, at each frequency three standards are selected, one each from S_{11A} , S_{11B} , and S_{11C} and used to compute the systematic error terms associated with port *i*. Similarly S_{22A} , S_{22B} , and S_{22C} are used for port *j*. Each class may include more than one standard, the specified minimum and maximum frequency of each standard in the class is used to determine which standard to use for a particular frequency. Usually, when multiple standards are listed in a class their frequency ranges have a finite overlap. For the 8510 and unguided calibration on the PNA, the last standard measured is used in the overlap region. Usually the load classes for a sliding load kit are defined with three load standards—a low band load, a sliding load and a broadband load. Often the low band load and the broadband load are the same physical device. The low band load has a reduced frequency range and is intended to be paired with the sliding load to cover the full frequency range of the kit. For users who desire a quicker, less accurate calibration, the broadband load is defined to cover the full frequency range. In the 8510 and PNA unguided calibration, if a user measured a sliding load then measured a broadband load, the calibration would be computed using only the broadband load ignoring the sliding load altogether. SmartCal (guided cal) in the PNA avoids this problem altogether by selecting the standards based on the order they are listed in the class, thus a sliding load will always have priority over a broadband load when it is listed before the broadband load.

Expanded calibration is a weighted least squares solution that uses the measurement of three or more standards. The least squares solution works well when all observations are trusted to the same degree. That is to say the actual response of each standard is known with the same accuracy. This is a reasonable assumption for ECal, but may not be valid when a least squares approach is applied to calibrations using other calibration kits due to the physical property differences of the standards.

Expanded math is a weighted least squares solution approach that provides a simple solution to handle the case where the observations are not all trusted to the same degree[12]. If the observations are all independent but not equally trusted, an optimal solution is best obtained by multiplying each equation by a weighting factor that includes both the accuracy of the standard's model and the proximity of the standard's response to the response of the other measured calibration standards. The accuracy of the standard model is explicitly defined for data-based standards, for the other standards a nominal accuracy is assigned to provide a relative weighting for the weighted least squares solution, Table 2. Default relative accuracy of cal standards types. The measurement of a standard is included in the weighted least squares solution over the frequency range where the accuracy of the standard is defined; this frequency range is greater than or equal to the frequency range where the standard is selected specified by the min/max frequencies. To avoid confusion in the following table, FMin and FMax correspond to the minimum and maximum frequency specified for the standard while UMin and UMax correspond to the minimum and maximum connector frequency. Also in the following table, endpoints are given; nominal accuracy at a given frequency is computed as a linear interpolation between the appropriate endpoints.

Table 2. Default relative accuracy of cal standards types

Standard type	Nominal accuracy			Frequency range	
	UMin	FMin	UMax	UMin	UMax
Open	0.01		$UMax/10^{12}$	Minimum connector frequency	Maximum connector frequency
Short	0.005		$UMax/10^{13}$	Minimum connector frequency	Maximum connector frequency
Fixed load	0.003		$3*UMax/10^{12}$	Minimum connector frequency	Maximum connector frequency
Sliding load	0.01	0.003	0.003	FMin/2	Maximum connector

Note

Nominal accuracy does not correspond to the accuracy of the calibration standards for any particular calibration kit—nominal accuracy should simply be considered as a default weighting.

When “use expanded math when possible” is checked the solution at each frequency all of the measured one-port standards will be included in the solution if frequency falls between UMin and UMax. For example, consider a sliding load calibration that includes frequencies in both the low band load and sliding load frequency ranges. The open, short, low band load and sliding load will be measured. At each frequency between UMin and UMax of the sliding load the computation will use expanded math. Using expanded math in this case will blend the transition between the low band load frequency range and the sliding load frequency range. As another example, the 85058B 1.85 mm calibration kit has a low-band load, an open and a series of short standards with varying offsets. There is a minimal set of standards defined that would insure calibration with three standards is possible at each frequency. The minimum and maximum frequency ranges for each standard combined with the class assignments will determine a set of three standards for each frequency resulting in a series of frequency ranges where only three standards would be required. If the VNA spans more than one of these frequency ranges there will be more than three reflection standards connected. In the case of the 85058B, in addition to blending the transitions between the frequency ranges, the overall accuracy of the calibration improves when using expanded math. There is an option to “measure all mateable standards in class” measuring all of the standards results in the best accuracy for kits like the 85058B and the 85059B. It is advantageous to measure all of the standards for some calibration kits, but not for others. For example, in the case of the sliding load kit discussed earlier, selecting measure all standards in class would result in measuring the low-band load, the sliding load and the broadband load. There is no advantage to measuring two fixed loads when doing a sliding load calibration.

TRL class assignment

The TRL/TRM family of calibration is defined by the TRL thru, reflect and line classes plus TRL options. Table 3 shows the TRL portion of a typical VNA class assignment table.

Table 3. TRL class assignment table

CLASS	A	B	C	D	E	F	G	Class Label
TRL thru	11	12						Thru
TRL reflect	2	4						Short
TRL line/match	14	15	9	10				Line/load
TRL options:								
Calibration reference impedance: System Z0 _____ Line Z0 _____								
Test port reference plane: Thru _____ Reflect _____								
(PNA only) <input type="checkbox"/> LRL line auto characterization								

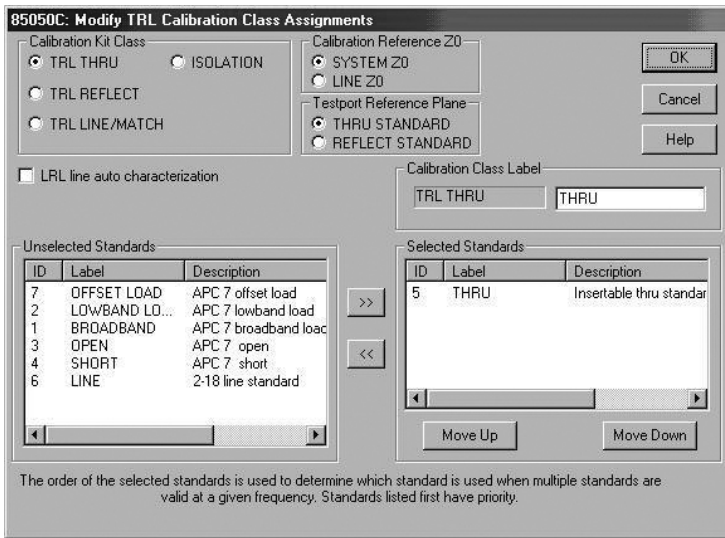

Figure 13. TRL edit class screen

TRL is a generic name that represents a class of calibrations that allow partially known calibration standards to be used. In general, the thru standard is assumed to be fully known with perfect match; the reflect standard is assumed to have a high reflection with unknown amplitude and partially known phase. The line standard is assumed to have the same propagation characteristics as the thru standard with partially known phase. Table 4 provides a mapping of specific calibration types to the TRL class.

Table 4. Mapping TRL standards to TRL class



	Thru class	Reflect class	Line class
TRL (thru/ reflect/line)	Zero length thru with $S_{11} = S_{22} = 0, S_{21} = S_{12} = 1$	Unknown equal reflect on port i and port j. Phase approximately known.	Line with $S_{11} = S_{22} = 0$ phase approximately known. Bandwidth limited to avoid phase of $\pm 20^\circ$.
LRL (line/reflect/ line)	Line1 with $S_{11} = S_{22} = 0, S_{21}$ and S_{12} both known with same propagation characteristics as Line2.	Unknown equal reflect on port i and port j. Phase approximately known.	Line2 with $S_{11} = S_{22} = 0$ phase approximately known. Bandwidth limited so phase is at least $\pm 20^\circ$ different from phase of Line 1.
TRM (thru/reflect/ match)	Zero length thru with $S_{11} = S_{22} = 0, S_{21} = S_{12} = 1$	Unknown equal reflect on port i and port j. Phase approximately known.	Can be defined as fixed loads on ports i and j $S_{11} = S_{22} = 0$. Can also be defined as very long lossy line
LRM (line/reflect/ match)	Line with $S_{11} = S_{22} = 0, S_{21}$ and S_{12} both known.	Unknown equal reflect on port i and port j. Phase approximately known.	Can be defined as fixed loads on ports i and j $S_{11} = S_{22} = 0$. Can also be defined as very long lossy line.
TRA (line/reflect/ attenuator)	Zero length thru with $S_{11} = S_{22} = 0, S_{21} = S_{12} = 1$	Unknown equal reflect on port i and port j. Phase approximately known.	Attenuator between ports I and j $S_{11} = S_{22} = 0$. Defined as lossy line.
LRA (line/reflect/ attenuator)	Line with $S_{11} = S_{22} = 0, S_{21}$ and S_{12} both known.	Unknown equal reflect on port i and port j. Phase approximately known.	Attenuator between ports I and j $S_{11} = S_{22} = 0$. Defined as lossy line.

The generalized TRL algorithm assumes the characteristic impedance of the line standard equals the desired system characteristic impedance. The calibration reference Z_0 option allows for adjustments to the calibration to account for small perturbations between the system Z_0 and the line characteristic impedance Z_c . This is derived from the defined Offset Z_0 and Offset Loss terms. See equation (2B.5) in “Appendix B” on page 32. If line Z_0 is selected, no adjustments are made.

Caution: Do not select System Z_0 if offset Z_0 of the line or match standard is very different from system Z_0 .

TRL calibration is computed initially at a reference plane that corresponds to the middle of the thru. In this case, the line standard can be assumed to be the portion of the line standard left over after subtracting a length equal to the length of the thru standard. After the error coefficients are computed, they are adjusted to establish a testport reference plane based on either the model of the thru standard or the model of the reflect standard. When selecting the reflect standard to set the testport reference plane, the assumption is that the reflect standard is precisely known as both magnitude and phase of the reflect standard will be used to compute the testport reference plane. Selecting the thru standard to set the reference plane obviously works for a zero length thru. In the case when the thru standard is a line with non-zero length, the model of the thru standard is used to compute the testport reference plane. In the case of coax or waveguide, using the model of the thru standard alone will provide excellent results. In the case of other dispersive media such as microstrip, the thru standard alone may give less than optimal results. One option would be to design the test fixture and calibration standards so that the testport would be located in the middle of the thru. Another alternative would be to select LRL line auto characterization. One of the by-products of the TRL algorithm is a computed value for the line standard propagation constant. This would include any dispersive effects of the transmission medium. When LRL line auto characterization is set the propagation characteristics of the thru standard are computed from the computed propagation characteristics of the line standard and the defined delays for both the thru and line standards. Note, LRL line auto characterization will only be used at frequencies where both the THRU and LINE standards are delay lines and where the offset impedance of the THRU and LINE standards are equal.

Table 5. TRL options and meaning

Calibration reference plane set			
			
	<input type="checkbox"/> LRL line auto characterization	<input type="checkbox"/> LRL line auto characterization	
LINE standard is a match standard	Reference plane set by THRU standard definition		
LINE standard is a delay line with defined offset Z_0 EQUAL to defined offset Z_0 of THRU standard	Reference plane set from estimated LINE propagation constant and specified delays of THRU and LINE standards.	Reference plane set by THRU standard definition	Reference plane set by REFLECT standard definition
LINE standard is a delay line with defined offset Z_0 NOT EQUAL to defined offset Z_0 of THRU standard	Reference plane set by THRU standard definition		

Modification Procedure

Calibration kit modification provides the capability to adapt to measurement calibrations to other connector types. Provided the appropriate standards are available, cal kit modification can be used to establish a reference plane in the same transmission media as the test devices. Additionally, the modification function allows the user to input more precise physical definitions for the standards in a given cal kit.

The process to modify or create a cal kit consists of the following steps:

1. Select **Modify Cal Kit**
2. Select **Kit, Import Kit** or **Create New**
3. Define the connector(s) [coax, waveguide etc.]
4. Select **Standards**
5. Define the standards
6. Select **Assign Classes**
7. Enter the standard types and classes
8. Select **Name** or **Rename Kit**

Note

Calibration kit entry and modification procedures for the Keysight ENA series of network analyzers are well documented in the Calibration Chapter of the ENA User's Guide, therefore, they are not covered in this document.

PNA calibration kit entry/modification procedure

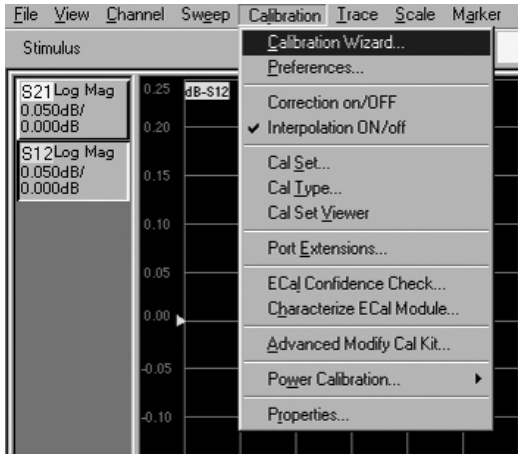

Use the “Advance Modify Cal Kit Wizard” on the PNA’s [Calibration] pull down menu to create or modify a calibration kit for the PNA.

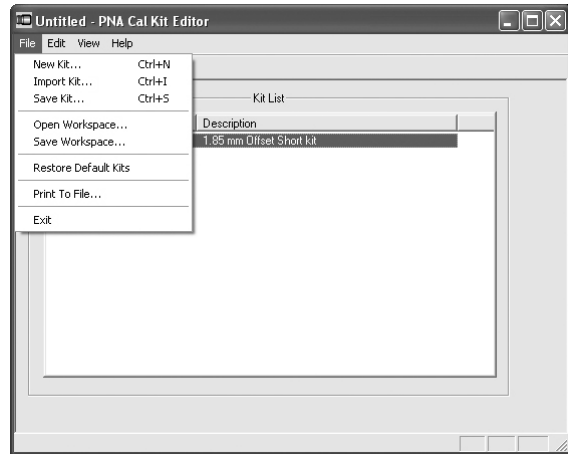

Or, download a PC executable PNA Cal Kit Editor program. The PC version may not be as updated as the PNA’s built-in version. Newer versions can process kit data created by an older version. The reverse may not be true.

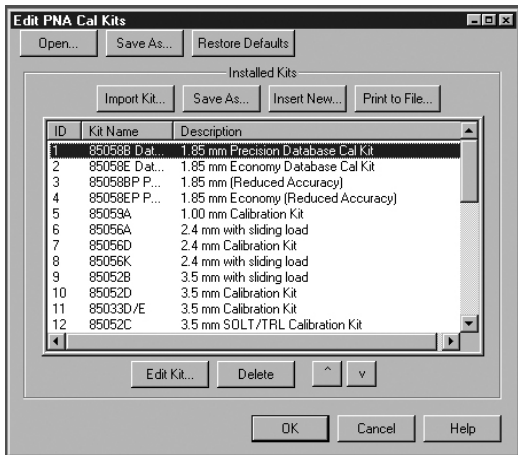

The PNA’s built-in cal kit editor will show a list of all cal kits files currently available and can be selected for modification. All current Keysight mechanical calibration kits are preinstalled in the factory cal kit file directory. If the kit of interest is not on the list, import the kit (instructions follow). Once on the list, select the kit, then click on [Edit Kit].

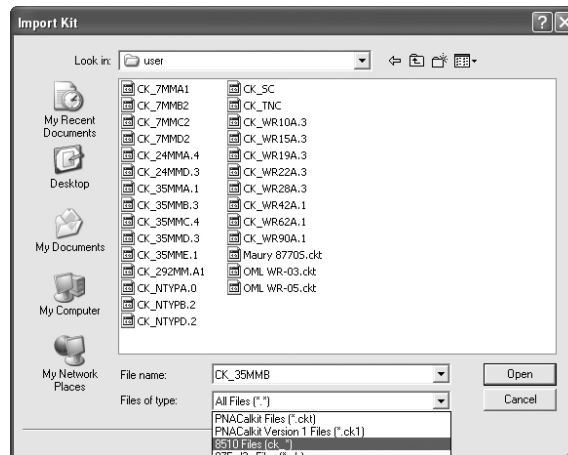

Cal Kits can be imported from other directories, the disc drive or the USB drive. Almost all previous versions of network analyzer data files can be imported. Some user created 8510 cal kit files and 87xx cal kit files may not import properly. Check the kit’s content after download to make sure all data entries are correct.

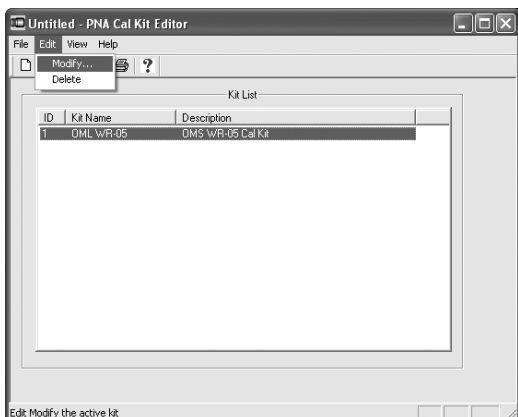

With the PC version, select a kit and then select [Edit] > [Modify].

Figure 14. Select and modify cal kit

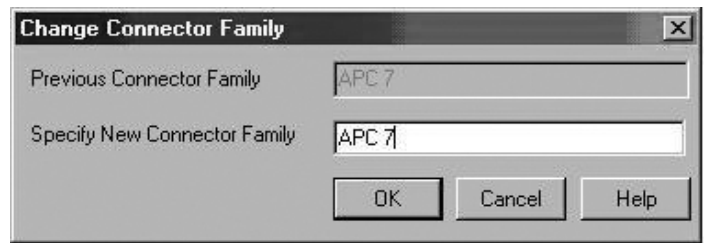

The cal kit's connector family can be renamed. The APC 7 connector family is being changed to 7mm.

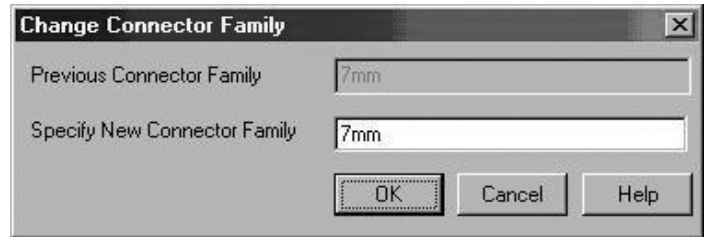

With the family name changes, all the kit's cal standard connector designations in the description field and the kit description field are updated as shown below

To set up a new kit, the connector family must be defined before adding calibration standards. Any changes to the connector definition must also be performed before editing the calibration standards.

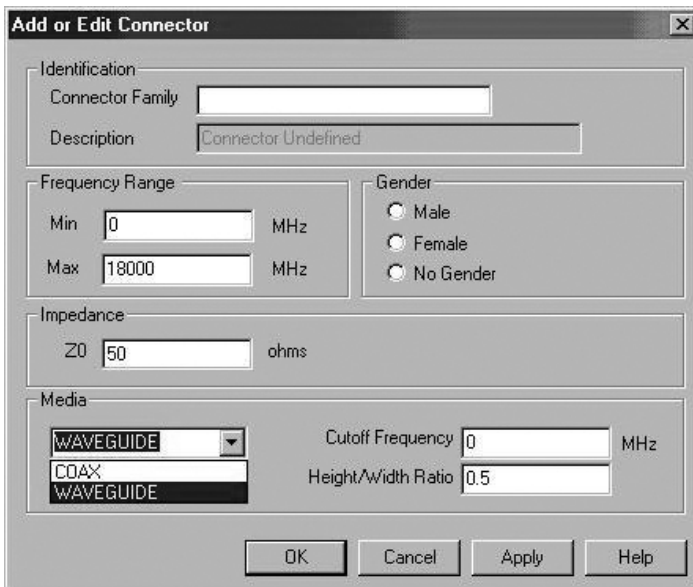

If the connectors **[Add or Edit]** feature is selected, the Add or Edit connector screen appears. The media section defines the transmission line type – COAX, WAVEGUIDE or others when available. If WAVEGUIDE is selected, the Cutoff Frequency and Height/Width Ratio entries are required. Male and female connectors must be specified separately. More than one connector family can be defined for a kit.

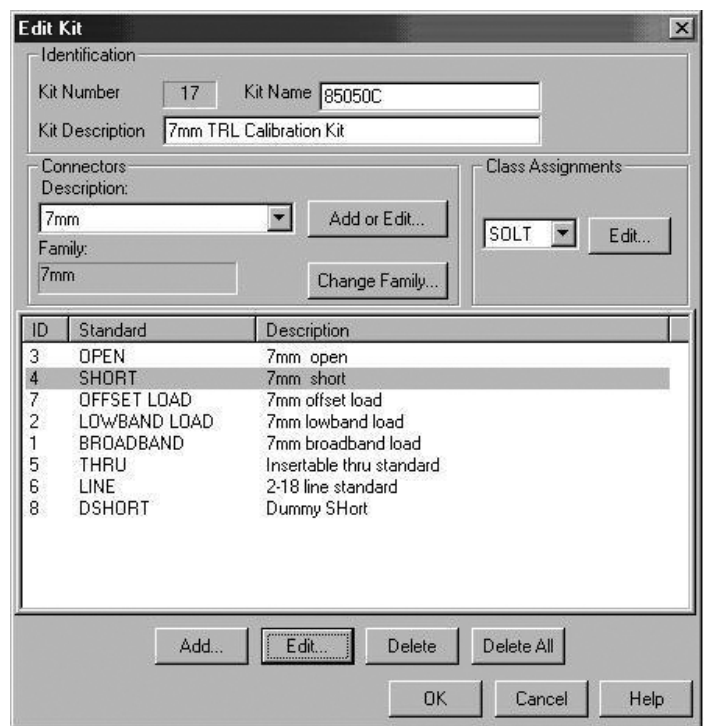

This shows the effect of a connector family name change from APC 7 to 7mm.

Next press the **[Add]** button to add the standards.

Figure 15. Define a new connector family

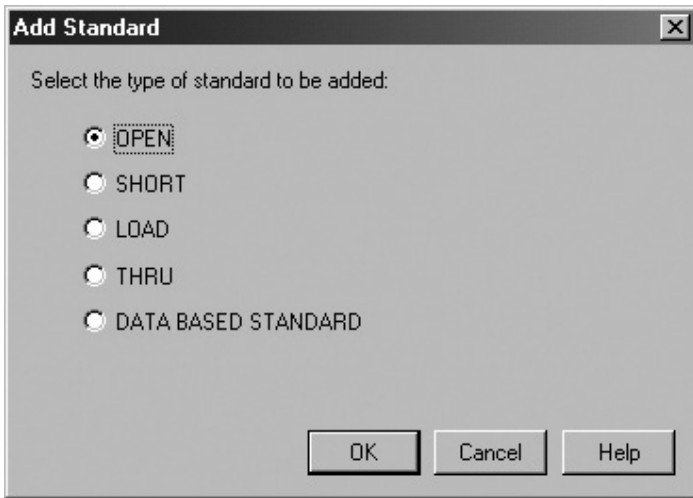

Add any one of the supported standard types. If open is selected, the open edit screen will appear, as shown on the right. The short standard edit screen is very similar to the open's. The load standard edit screen is shown below.

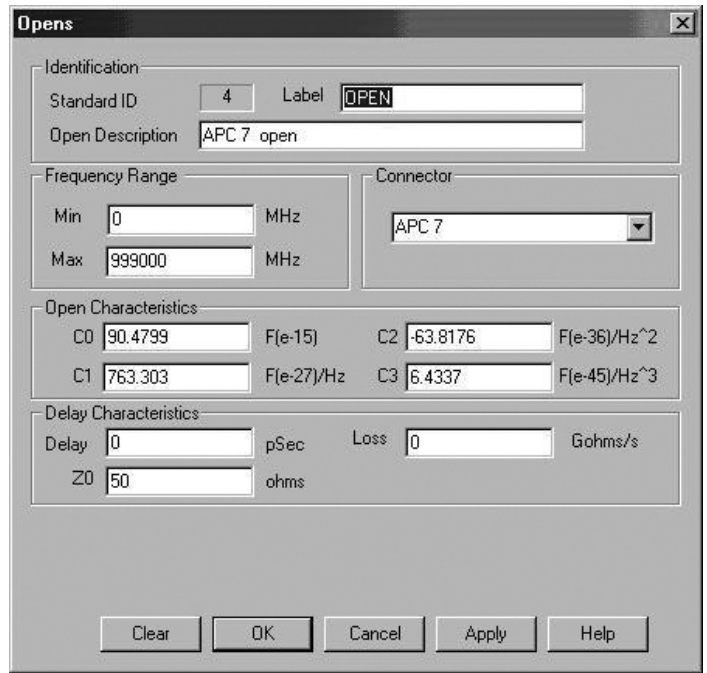

Enter all the fields. Make sure the units of measurements, such as the exponents, are correct,.

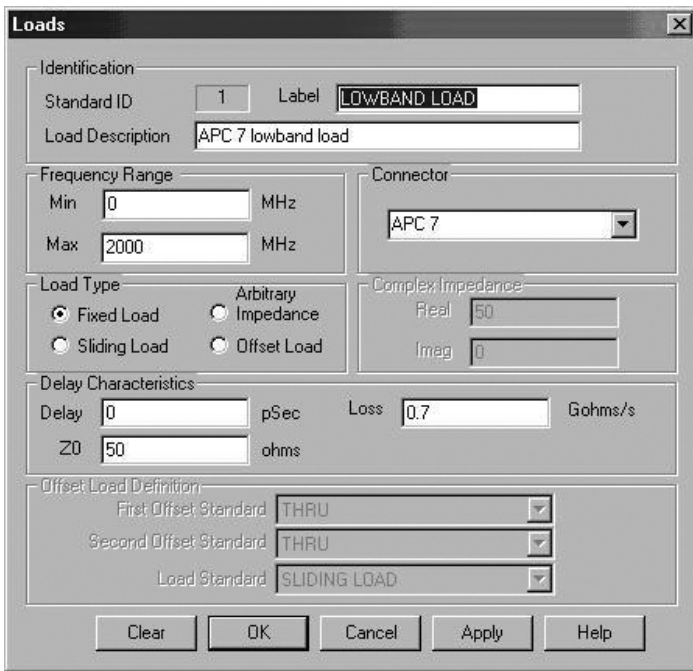

There are 4 load types. Each activates a different set of data entry fields. Fixed and sliding loads are similar.

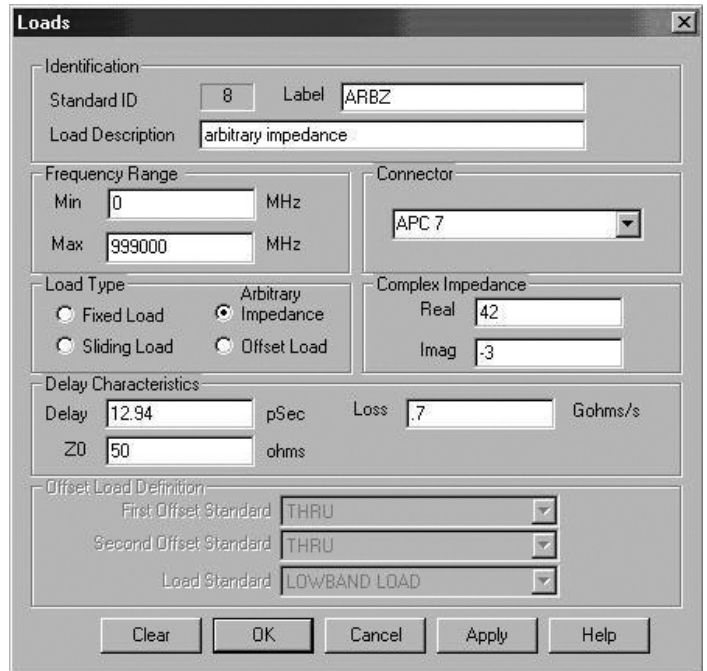

Note, Arbitrary impedance activates the complex impedance entry field.

Figure 16. Add standards

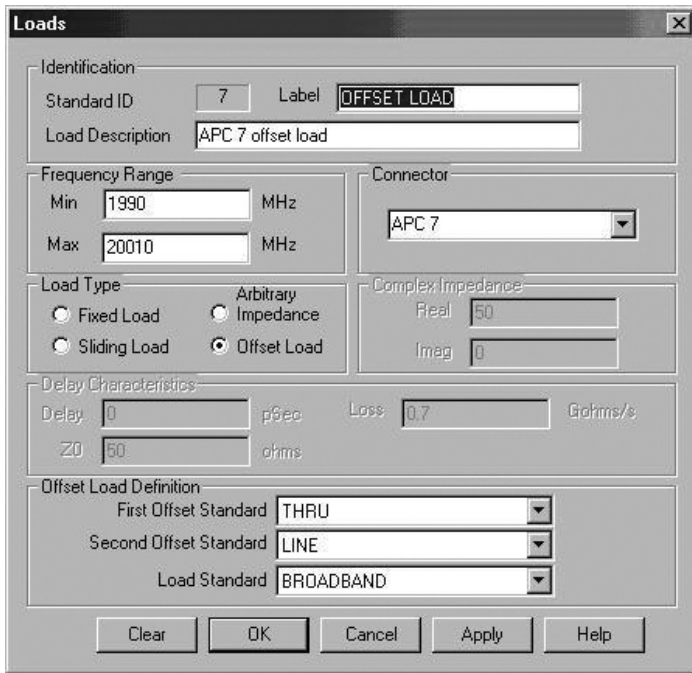

Offset load activates the “Offset Load Definition” field.

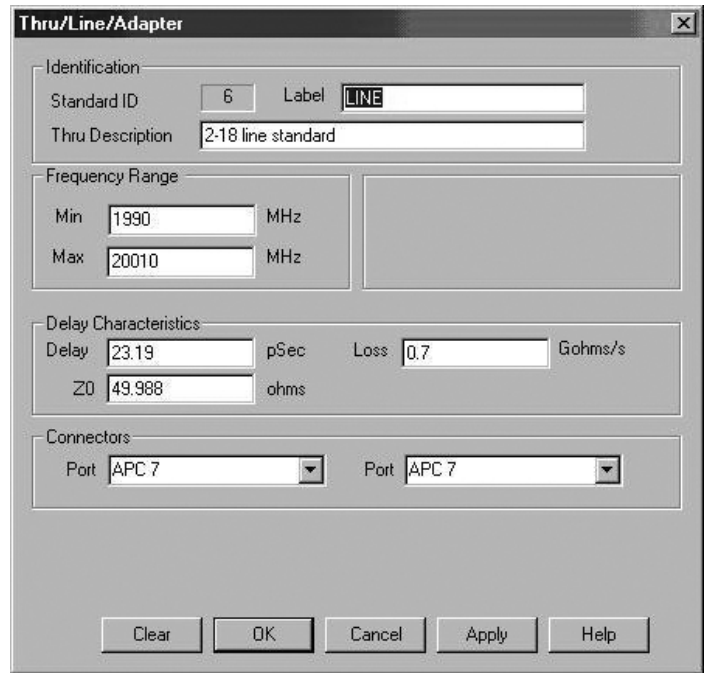

The Thru/Line/Adapter edit/entry screen is activated by choosing the thru standard type. Note that “connectors” need to be defined for both ports. They can be used to define an adapter.

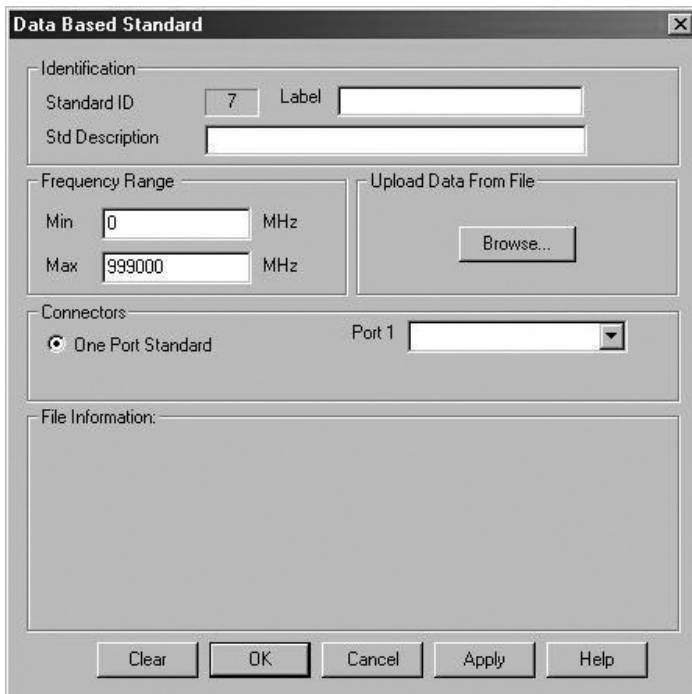

Use [Browse] to locate the data-based file and upload it. If successful, the file information screen will summarize the file’s content. File information is only available at initial installation. Subsequent viewing of an existing standard is not yet supported

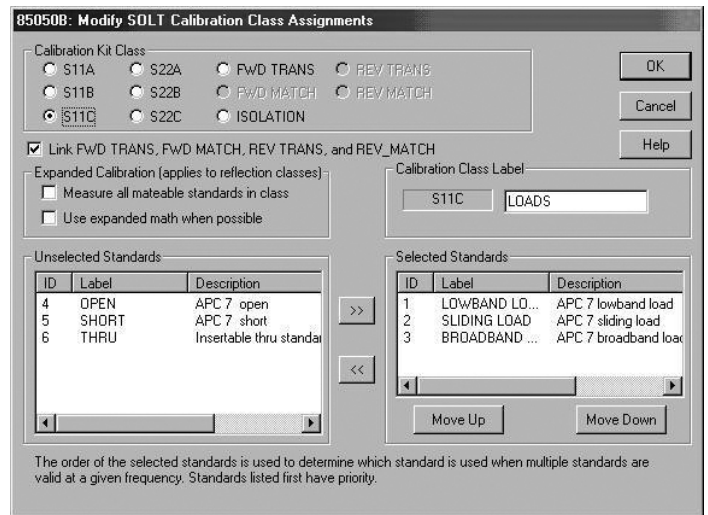

After all the standards are defined. They need to be assigned to classes. Class assignment details were discussed earlier in this application note.

The final step is to complete the kit description and save the kit.

Figure 17. Complete standard definitions and assign to classes

8510 Calibration kit modification/entry procedure

Calibration kit specifications can be entered into the Keysight 8510 vector network analyzer using the disk drive, a disk drive connected to the system bus, by front panel entry, or through program control by an external controller.

Disk procedure

This is an important feature since the 8510 can only store two calibration kits internally at one time, while multiple calibration kits can be stored on a single disk.

Below is the generic procedure to load or store calibration kits from and to the disk drive or disk interface.

To load calibration kits from disk into the Keysight

1. Insert the calibration data disk into the network analyzer (or connect compatible disk drive to the system bus).
2. Press the DISC key; select STORAGE IS: INTERNAL or EXTERNAL; then press the following display softkeys: LOAD CAL KIT 1-2 CAL KIT 1 or CAL KIT 2 (This selection determines which of the non-volatile registers that the calibration kit will be loaded into.) FILE #_ or FILE NAME (Select the calibration kit data to load.) LOAD FILE.
3. To verify that the correct calibration kit was loaded into the instrument, press the CAL key. If properly loaded, the calibration kit label will be shown under "CAL 1" or "CAL 2" on the CRT display.

To store calibration kits from the Keysight onto a disk

1. Insert an initialized calibration data disk into the network analyzer or connect compatible disk drive to the system bus.
2. Press the DISC key; select STORAGE IS: INTERNAL or EXTERNAL; then press the following CRT displayed softkeys: STORE CAL KIT 1-2 CAL KIT 1 or CAL KIT 2 (This selection determines which of the non-volatile calibration kit registers is to be stored.) FILE #_ or FILE NAME (Enter the calibration kit data file name.) STORE FILE.
3. Examine directory to verify that file has been stored. This completes the sequence to store a calibration kit onto a disk.

To generate a new cal kit or modify an existing one, either front panel or program controlled entry can be used.

In this guide, procedures have been given to define standards and assign classes. This section will list the steps required for front panel entry of the standards and appropriate labels.

Front panel procedure: (P-band waveguide example)

1. Prior to modifying or generating a cal kit, store one or both of the cal kits in the 's non-volatile memory to a disk.
2. Select **CAL** menu > **MORE**.
3. Prepare to modify cal kit 2: press **MODIFY 2**.
4. To define a standard: press **DEFINE STANDARD**.
5. Enable standard no. 1 to be modified: press **1, X1**.
6. Select standard type: **SHORT**.
7. Specify an offset: **SPECIFY OFFSETS**.
8. Enter the delay from Table 1: **OFFSET DELAY**, 0.0108309, ns.
9. Enter the loss from Table 1: **OFFSET LOSS**, 0, X1.
10. Enter the Z0 from Table 1: **OFFSET Z0**, 50, X1.
11. Enter the lower cutoff frequency: **MINIMUM FREQUENCY**, 9.487 GHz.
12. Enter the upper frequency: **MAXIMUM FREQUENCY**, 18.97 GHz.
13. Select **WAVEGUIDE**.
14. Prepare to label the new standard: press **PRIOR MENU > LABEL STANDARD > ERASE TITLE**.
15. Enter **PSHORT 1** by using the knob, **SELECT > LETTER** softkey and **SPACE** softkey.
16. Complete the title entry by pressing **TITLE DONE**.
17. Complete the standard modification by pressing **STANDARD DONE (DEFINED)**.

Standard #1 has now been defined for a $1/8 \lambda$ P-band waveguide offset short. To define the remaining standards, refer to Table 1 and repeat steps 4-17. To define standard #3, a matched load, specify "fixed."

The front panel procedure to implement the class assignments of Table 2 for the P-band waveguide cal kit are as follows:

1. Prepare to specify a class: **SPECIFY CLASS**.
2. Select standard class **S_{11A}**.
3. Direct the network analyzer to use standard no. 1 for the 11A class of calibration: **1, X1, CLASS DONE (SPECIFIED)**.

Change the class label for S₁₁A: **LABEL CLASS**, **11A**, **ERASE TITLE**.

1. Enter the label of **PSHORT 1** by using the knob, the **SELECT** softkey and the **SPACE** softkey.
2. Complete the label entry procedure: **TITLE DONE > LABEL DONE**.

Follow a similar procedure to enter the remaining standard classes and labels as shown in the table below:

Finally, change the cal kit label as follows:

1. Press **LABEL KIT > ERASE TITLE**.
2. Enter the title **"P BAND."**
3. Press **TITLE DONE > KIT DONE (MODIFIED)**. The message **"CAL KIT SAVED"** should appear.

This completes the entire cal kit modification for front panel entry. An example of programmed modification over the GPIB bus through an external controller is shown in the *"Introduction To Programming"* section of the *8510 Network Analyzer Operating and Service Manual (Section III)*.

Table 6. 8510 class assignment table

Standard class	Standard numbers	Class label
S ₁₁ B	2	PSHORT 2
S ₁₁ C	3	PLOAD
S ₂₂ A	1	PSHORT1
S ₂₂ B	2	PSHORT2
S ₂₂ C	3	PLOAD
FWD TRANS	4	THRU
FWD MATCH	4	THRU
REV TRANS	4	THRU
REV MATCH	4	THRU
RESPONSE	1, 2, 4	RESPONSE

Appendix A: Dimensional Considerations in Coaxial Connectors

This appendix describes dimensional considerations and required conventions used to determine the physical offset length of calibration standards in sexed coaxial connector families.

Precise measurement of the physical offset length is required to determine the OFFSET DELAY of a given calibration standard. The physical offset length of one and two-port standards is as follows.

- One-port standard – Distance between “calibration plane” and terminating impedance.
- Two- port standard – Distance between the Port 1 and Port 2 “calibration planes.”

The definition (location) of the “calibration plane” in a calibration standard is dependent on the geometry and sex of the connector type. The “calibration plane” is defined as a plane which is perpendicular to the axis of the conductor coincident with the outer conductor mating surface. This mating surface is located at the contact points of the outer conductors of the test port and the calibration standard. To illustrate this, consider the following connector type interfaces:

7-mm coaxial connector interface

The “calibration plane” is located coincident to both the inner and outer conductor mating surfaces as shown in Figure 18. Unique to this connector type is the fact that the inner and outer conductor mating surfaces are located coincident as well as having hermaphroditic (sexless) connectors. In all other coaxial connector families this is not the case.

3.5-mm, 2.4-mm, 1.85-mm, 1.0-mm coaxial connector interface

The location of the “calibration plane” in these connector standards, both sexes, is at the outer conductor mating surface as shown in Figure 18.

Type-N coaxial connector interface

The location of the “calibration plane” in Type-N standards is the outer conductor mating surfaces as shown in Figure 19.

For the PNA family, the device label uses **-M-** or **-F-** to indicate the **sex of the calibration** standard instead of the test port.

(M) or (F) & sex of the test port,
-M- or **-F-** & sex of the calibration standard

Note

During measurement calibration using the 8510 and its derivatives, standard labels for the calibration standard indicate both the standard type and the sex of the calibration test port, (M) or (F). The sex (M) or (F) indicates the sex of the test port, NOT the sex of the standard. This port sex labeling convention must be observed and followed so that the correct calibration standard is connected to the calibration port. This is especially important for calibration kits that have different calibration coefficients for the male and female standards, such as the Type-N, 1.85-mm and 1.0-mm calibration kits.

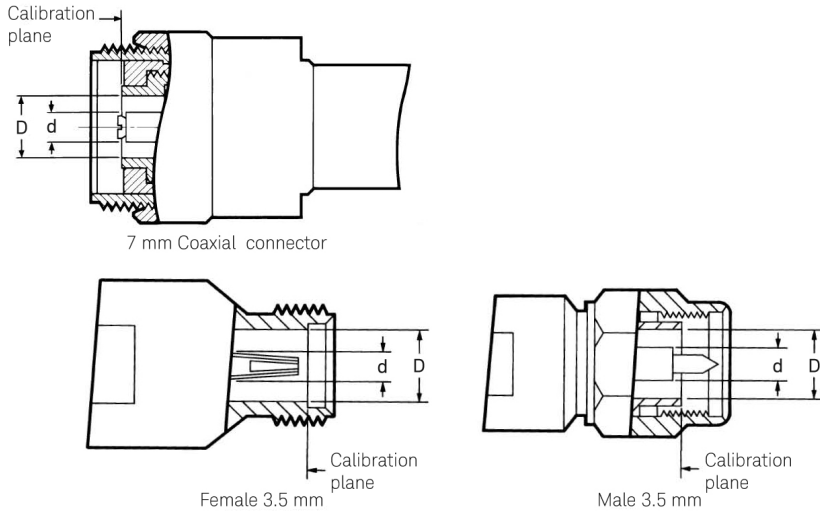

Figure 18. Location of coaxial connector calibration plane

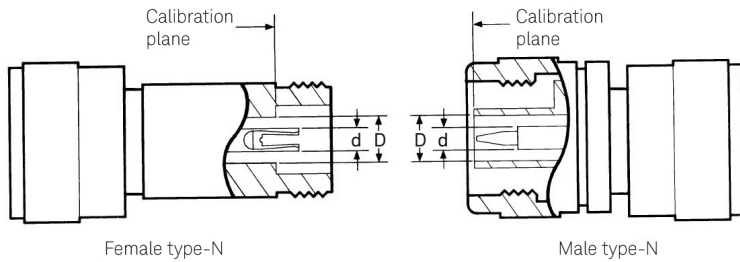

Figure 19. Type-N connector calibration plane

Appendix B: Derivation of Coaxial Calibration Coefficient Model

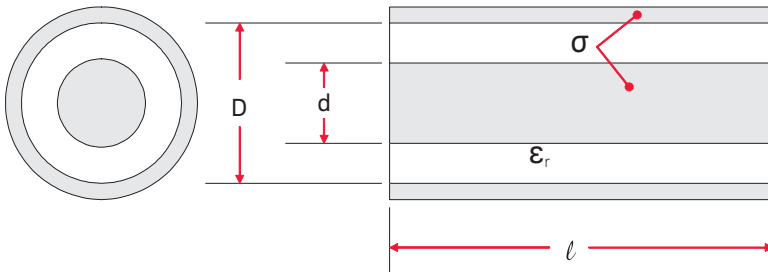

Figure 20. Coaxial transmission line characteristics

All transmission lines may be defined by their characteristic impedance (Z_C), propagation loss constant (α), propagation phase constant (β), and length. They are related to the calibration coefficients - **Offset Z_0** , **Offset Loss**, and **Offset Delay** - as follows:

Recall that:

Transmission loss and phase = $e^{-(\alpha+j\beta)l}$

$$(\alpha + j\beta) = \sqrt{(R + j\omega L)(G + j\omega C)}$$

$$Z_c = \sqrt{\frac{R + j\omega L}{G + j\omega C}}$$

$R \equiv$ distributed resistance offset line;

$L \equiv$ distributed inductance offset line;

$G \equiv$ distributed conductance offset line;

$C \equiv$ distributed capacitance offset line;

$\omega \equiv 2\pi f$; $f \equiv$ frequency in Hz; $l \equiv$ length

(2B.1)

Assume that R is small and $G=0$, including the self inductance of imperfect conductors, the second order approximation of the transmission line characteristics are:

$$L = L_o + L_i = L_o + \frac{R}{\omega}$$

$$(\alpha + j\beta) \cong j\omega\sqrt{L_o C} \left[1 + (1-j) \left(\frac{R}{2\omega L_o} \right) \right]$$

$$Z_c \cong \sqrt{\frac{L_o}{C}} \left[1 + (1-j) \left(\frac{R}{2\omega L_o} \right) \right]$$

(2B.2)

For coaxial transmission lines, let:

$$\begin{aligned} \text{Offset loss} &= \frac{R_v}{\sqrt{\epsilon_r f / 10^9}} \\ \text{Offset delay} &= \frac{\sqrt{\epsilon_r}}{v} = \sqrt{L_o C} \\ R &= \sqrt{\frac{\pi f \mu_0}{\sigma_c}} \left(\frac{1}{\pi d} + \frac{1}{\pi D} \right) \end{aligned} \quad (2B.3)$$

$$\begin{aligned} \text{Given: } L_o &= \left(\frac{\mu_0}{2\pi} \right) \ln \left(\frac{D}{d} \right); \quad c = \frac{2\pi \epsilon_0 \epsilon_r}{\ln(D/d)}; \quad \epsilon_0 = \frac{1}{\mu_0 v^2} \\ \text{Offset } Z_o &= \sqrt{\frac{L_o}{C}} = \frac{\mu_0 v}{2\pi \sqrt{\epsilon_r}} \ln \left(\frac{D}{d} \right) \end{aligned} \quad (2B.4)$$

Substituting the offset definitions back to the transmission line equations (2B.2):

$$\begin{aligned} \left(\frac{R}{2\omega L_o} \right) &= \left(\frac{\text{Offset loss}}{2\omega(\text{Offset } Z_o)} \right) \sqrt{\frac{f}{10^9}} \\ \alpha l &= \left[\frac{(\text{Offset loss})(\text{Offset delay})}{2(\text{Offset } Z_o)} \right] \sqrt{\frac{f}{10^9}} \\ \beta l &= \omega(\text{Offset delay}) + \alpha l \quad [\text{Note: } \beta \cong (\omega/v) + \alpha] \\ Z_c &= (\text{Offset } Z_o) + (1-j) \left(\frac{\text{Offset loss}}{2\omega} \right) \sqrt{\frac{f}{10^9}} \end{aligned} \quad (2B.5)$$

The short's inductance may be determined from physical properties of the shorting plane, as presented in reference [10]. The computed results are then curve fitted to a third order polynomial function.

$$\begin{aligned} Z_T &\approx j\omega L_T; \quad L_T = L_0 + L_1 f + L_2 f^2 + L_3 f^3 \\ \Gamma_T &\approx (-1)e \end{aligned} \quad (2B.6)$$

At low frequencies where the inductance is reasonably linear, it may be modeled as an extra delay term.

$$\Delta\phi = 2\arctan\left(\frac{2\pi fL_T}{Z_r}\right) = 2\pi f(\Delta\text{delay}) \quad (2B.7)$$

The open's fringing capacitance may be determined using three dimension microwave structure simulators. However, the mechanical structure of the open assembly can be quite complex and can cause simulation problems. It may be more realistic to measure the open's response using TRL or offset short calibration techniques where opens are not employed as calibration standards. The measured results are then curve fitted to a third order polynomial capacitance model.

$$Z_T \approx \frac{1}{j\omega C_T}; \quad C_T = C_0 + C_1f + C_2f^2 + C_3f^3$$

$$\Gamma_T \approx (1)e^{-2j\arctan(\omega C_T Z_r)} \quad (2B.8)$$

At low frequencies where the capacitance is reasonably linear, it may be modeled as an extra delay term.

$$\Delta\phi = 2\arctan(2\pi f C_T Z_r) = 2\pi f(\Delta\text{delay}) \quad (2B.9)$$

Appendix C1: Derivation of Waveguide Calibration Coefficient Model

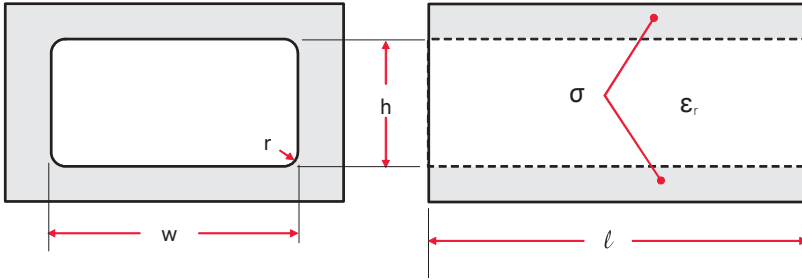

Figure 22. Rectangular waveguide dimensions and properties

The physical properties of a rectangular waveguide are illustrated in Figure 22.

$$\beta = \frac{2\pi f}{v} \sqrt{1 - \left(\frac{\lambda}{2w_e}\right)^2} \quad (\text{C1.10})$$

where $v = \frac{c}{\sqrt{\epsilon_r}}$ = speed of light in guide medium, $\lambda = \frac{v}{f}$ = TEM wave length in guide medium, and $w_e = w - \frac{(4 - \pi)r^2}{h}$ = effective guide width. Assuming the guide medium is low loss permits the attenuation coefficient to be defined by the conductive losses given as:

$$\alpha \approx \frac{\sqrt{\pi f \mu_0 \rho}}{h} \sqrt{\frac{\epsilon_0 \epsilon_r}{\mu_0} \left(1 + \frac{2h}{w_e} \left(\frac{\lambda}{2w_e}\right)^2\right)} \sqrt{1 - \left(\frac{\lambda_0}{2w_e}\right)^2} \quad (\text{C1.11})$$

where $\rho = \frac{1}{\sigma}$ = resistivity of the conductor and $2\omega_c = \lambda_c =$ guide cut off wave length $= \frac{v}{f_c}$
then $\frac{\lambda}{2w_e} = \frac{f_c}{f}$.

To structure the waveguide loss equation in calibration coefficient format for the VNA, offset loss must be in G ohm/s. The equation may be reformulated as follows:

$$\alpha l \approx \frac{l \sqrt{\pi f_c \mu_0 \rho}}{h} \left(\sqrt{\frac{f}{f_c}} \right) \sqrt{\frac{\epsilon_0 \epsilon_r}{\mu_0}} \frac{\left(1 + \frac{2h}{w_e} \left(\frac{f_c}{f} \right)^2 \right)}{\sqrt{1 - \left(\frac{f_c}{f} \right)^2}} \quad (C1.12)$$

Let $D_0 = \frac{l}{v} =$ offset delay and $L_0 = v \frac{\sqrt{\pi f_c \mu_0 \rho}}{h} =$ offset loss then

$$\alpha l \approx L_0 D_0 \sqrt{\frac{\epsilon_0 \epsilon_r}{\mu_0}} \sqrt{\frac{f}{f_c}} \frac{\left(1 + \frac{2h}{w_e} \left(\frac{f_c}{f} \right)^2 \right)}{\sqrt{1 - \left(\frac{f_c}{f} \right)^2}} \quad (C1.13)$$

The combine propagation constant is given as:

$$\gamma l = (\alpha + j\beta)l \approx \left[L_0 \sqrt{\frac{\epsilon_0 \epsilon_r}{\mu_0}} \sqrt{\frac{f}{f_c}} \frac{\left(1 + \frac{2h}{w_e} \left(\frac{f_c}{f} \right)^2 \right)}{\sqrt{1 - \left(\frac{f_c}{f} \right)^2}} + j2\pi f \sqrt{1 - \left(\frac{f_c}{f} \right)^2} \right] D \quad (C1.14)$$

Appendix C2: Derivation of Circular Waveguide Calibration Coefficient Model

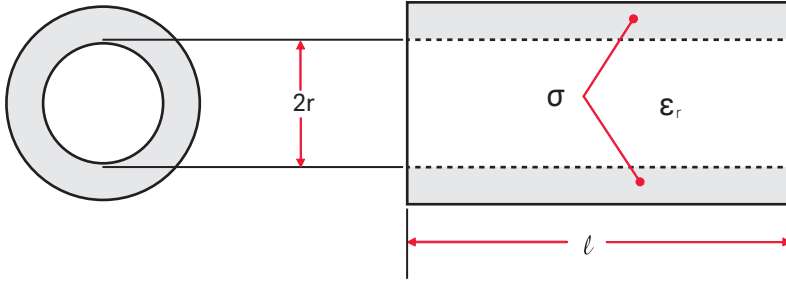

Figure 23: Circular waveguide dimensions and properties

The physical properties of a circular waveguide are illustrated in Figure 23.

$$\beta_{mn} = \frac{2\pi f}{v} \sqrt{1 - \left(\frac{\lambda}{\lambda_{c,mn}}\right)^2} \quad (C1.15)$$

where $v = \frac{c}{\sqrt{\epsilon_r}}$ = speed of light in guide medium, $\lambda = \frac{v}{f}$ = TEM wave length in guide medium, and $\lambda_{c,mn}$ = circular guide cut off frequency = $\frac{2\pi}{\chi_{mn}} r \sqrt{\epsilon_r}$. For the H_{11} waveguide mode $\chi_{11} = 1.841$. Assuming the guide medium is low loss permits the attenuation coefficient to be defined by the conductive losses given as:

$$\alpha_{mn} = \kappa_{mn} \frac{\sqrt{\pi f_{c,mn} \rho \mu_0}}{r} \sqrt{\epsilon_0 \epsilon_r} \sqrt{\frac{f}{f_{c,mn}}} \frac{\left(1 + \frac{1}{\kappa_{mn}} \left(\frac{\lambda}{\lambda_{c,mn}}\right)^2\right)}{\sqrt{1 - \left(\frac{\lambda}{\lambda_{c,mn}}\right)^2}} \quad (C1.16)$$

where $\rho = \frac{1}{\sigma}$ = resistivity of the conductor, $\lambda_{c,mn}$ = guide cut off wave length = $\frac{v}{f_{c,mn}}$ then $\frac{\lambda}{\lambda_{c,mn}} = \frac{f_{c,mn}}{f}$, and $\kappa_{mn} = \frac{m^2}{\chi_{mn}^2 - m^2} \Rightarrow \kappa_{11} = 0.4185|_{H_{11}}$

To structure the waveguide loss equation in calibration coefficient format for the VNA, offset loss must be in G ohm/s. The equation may be reformulated as follows:

Let $D_o = \frac{l}{v} =$ offset delay and $L_o = v\kappa_{mn} \frac{\sqrt{\pi f_{c,mn} \rho \mu_0}}{r} =$ offset loss then

$$\alpha l \approx L_o D_o \sqrt{\frac{\epsilon_0 \epsilon_r}{\mu_0}} \sqrt{\frac{f}{f_c}} \frac{\left(1 + 2 \left(\frac{1}{2\kappa_{mn}}\right) \left(\frac{f_c}{f}\right)^2\right)}{\sqrt{1 - \left(\frac{f_c}{f}\right)^2}} \quad (C1.17)$$

Note that the $\left(\frac{1}{2\kappa}\right)$ term is equivalent to $\left(\frac{h}{w_e}\right)$ height width ratio of rectangular waveguides. Use this as the height/width ratio value when creating calibration kit definitions for circular waveguide.

The combined propagation constant is given as:

$$\gamma l = (\alpha + j\beta)l \approx \left[L_o \sqrt{\frac{\epsilon_0 \epsilon_r}{\mu_0}} \sqrt{\frac{f}{f_c}} \frac{\left(1 + 2 \left(\frac{1}{2\kappa_{mn}}\right) \left(\frac{f_c}{f}\right)^2\right)}{\sqrt{1 - \left(\frac{f_c}{f}\right)^2}} + j2\pi f \sqrt{1 - \frac{(f_c)^2}{f}} \right] D_o \quad (C1.18)$$

Appendix D: Data-based Calibration Standard Definition File Format

A beta release of the calibration kit editor is available at <http://na.tm.keysight.com/pna/dbcal.html>. This editor will allow the creation of kits that include data-based standards. Data-based standards are described by a data list. A data-based standard should include a list of frequencies, the actual response for each s-parameter at each frequency and an estimate of the accuracy of the actual response to be used in determining the weighting factor.

Currently only one-port devices are supported. Support for two-port devices will be added later.

Example file

```

CITIFILE A.01.01
#PNA Rev A.01.00
#PNA STDTYPE DATABASED
COMMENT MODEL: 85058-60101
COMMENT SERIAL NUMBER: NOMINAL
#PNA STDREV Rev A.01.00
#PNA STDLABEL "SHORT 1 -M-"
#PNA STDDESC "1.85 mm male [SHORT 1]"
#PNA STDFRQMIN 0
#PNA STDFRQMAX 70000000000
#PNA STDNUMPORTS 1
COMMENT "1.85 mm" known so #PNA DEFINECONNECTOR statement non needed
COMMENT #PNA DEFINECONNECTOR "1.85 mm" 0 70000000000 COAX
#PNA CONNECTOR 1 "1.85 mm" MALE
COMMENT PINDEPTH is optional, only applies to coax devices
#PNA PINDEPTH 1 0.007 0.007

NAME DATA
COMMENT This section describes the s parameter data and weighting
COMMENT factor for the calibration standard
COMMENT COVERAGEFACTOR is used to scale the weighting factor
COMMENT S[i,j] is sij for the standard. Supported formats: RI
COMMENT U[i,j] is the weighting factor for sij.
COMMENT Supported U[i,j] formats: RI, MAG
#PNA COVERAGEFACTOR 2
COMMENT note number of points is 509 below
VAR Freq MAG 509
DATA S[1,1] RI
DATA U[1,1] MAG
VAR_LIST_BEGIN
0
10000000
15000000
...
70000000000
VAR_LIST_END
BEGIN
-1,0
-0.99976354927,0.00249289367
-0.99970950119,0.00367766097
...
0.9772034982,-0.14575300423
END
BEGIN
0.00028
0.00028
0.00028
...
0.005
END

```

Preliminary #PNA keywords

The PNA currently does not recognize the following keywords (they are ignored). Future revisions will include the following keywords to allow the data-based standard to be completely defined by the CITIFILE.

Table 7. #PNA keyword table (preliminary)

Statement	Explanation
#PNA REV s	#PNA revision
#PNA STDTYPE s	Calibration standard type s can be DATABASED
#PNA STDREV s	Standard revision
#PNA STDLABEL s	Standard label
#PNA STDDESC s	Standard description
#PNA STDFRQMIN f	Min frequency for standard selection (may be different from range of use) (Hz)
#PNA STDFRQMAX f	Max frequency for standard selection (may be different from range of use) (Hz)
#PNA STDNUMPORTS d	Number of ports, default 1
#PNA PINDEPTH d f1 f2	Indicates pin depth for coaxial connectors to allow for pin depth compensation to the model d= port number f1= value included in the model data (mm) f2= actual value (mm)
#PNA DEFINECONNECTOR s1 f1 f2 s2 <f>	Defines connector (NOT NEEDED IF PREDEFINED) s1= connector ID f1= minimum frequency (Hz) f2= maximum frequency (Hz) s2= connector type can be COAX, WAVEGUIDE, <f> is an optional list of parameters to specify values <f> is ignored for COAX <f> the first element is cutoff frequency for WAVEGUIDE <f> to be determined for other types
#PNA CONNECTOR d s1 s2	Connector assignment d= port number s1= connector ID corresponding to predefined ID or one defined by DEFINECONNECTOR s2= connector sex can be MALE, FEMALE, NONE
#PNA COVERAGEFACTOR f	Coverage factor for weighting default f = 1

References

1. D. Rytting. "An Analysis of Vector Measurement Accuracy Enhancement Techniques", Hewlett-Packard RF & Microwave Measurement Symposium and Exhibition. Mar. 1987.
2. D. Rytting. "Appendix to an Analysis of Vector Measurement Accuracy Enhancement Techniques", Hewlett-Packard RF & Microwave Measurement Symposium and Exhibition. Mar. 1987.
3. D. Rytting. "Network Analyzer Error Models and Calibration Methods, RF & Microwave Measurements for Wireless Applications", ARFTG/NIST Short Course Notes. 1996.
4. G.F. Engen, C.A. Hoer. "Thru-Reflect-Line: An Improved Technique for Calibrating the Dual 6-Port Automatic Network Analyzer", IEEE Trans Microwave Theory Tech., vol. MTT-27, pp 983-987. Dec. 1979.
5. R.A. Speciale. "A Generalization of the TSD Network Analyzer Calibration Procedure, Covering N-port Scattering Parameter Measurements, Affected by Leakage Errors", IEEE Trans. Microwave Theory Tech., vol MTT-24, pp. 1100-1115. Dec 1977.
6. E.J. Eul, B. Schiek. "A Generalized Theory and New Calibration Procedure for Network Analyzer Self-Calibration", IEEE Trans. Microwave Theory Tech., vol 39, pp 724-731. Apr. 1991.
7. R.B. Marks. "Formulations of the Basic Vector Network Analyzer Error Model Including Switch Terms", 50th ARFTG Conference Digest, pp. 115-126. Fall 1997.
8. D. Blackham, K. Wong. "Latest Advances in VNA Accuracy Enhancements", Microwave Journal, pp. 78-94. July 2005.
9. K.H. Wong. "Using Precision Coaxial Air Dielectric Transmission Line as Calibration and Verification Standards", Microwave Journal, pp 88-92. Dec. 1988.
10. K.H. Wong. "Characterization of Calibration Standards by Physical Measurements", 39th ARFTG Conference Digest. June 1992.
11. N. Marcuvitz. "Waveguide Handbook", McGraw-Hill, NY, 1955. Reprint Peter Peregrinus Lt. 1986.
12. G. Strang. "Linear Algebra and Its Applications", 2nd ed. New York, New York: Academic Press, Inc. 1980.
13. D.J. Bannister, E.J. Griffin, T.E. Hodgetts. "On the Dimensional Tolerances of Rectangular Waveguide for Reflectometry at Millimetric Wavelengths", NPL Report DES 95. Sep 1989.
14. N. Marcuvitz, "Waveguide Handbook", Sec. 2.3, IEE Electromagnetic Waves Series 21, Peter Peregrinus Ltd. 1986.



Evolving

Our unique combination of hardware, software, support, and people can help you reach your next breakthrough. **We are unlocking the future of technology.**

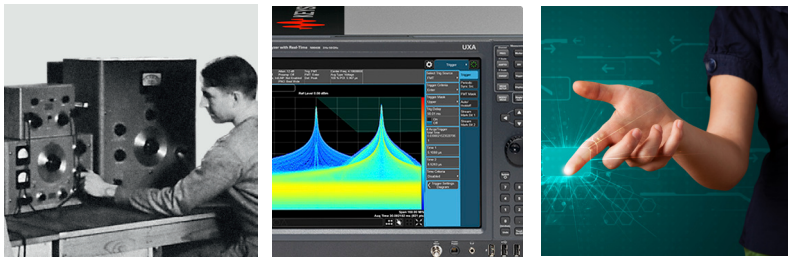

From Hewlett-Packard to Agilent to Keysight



myKeysight

myKeysight

myKeysight

www.keysight.com/find/mykeysight

A personalized view into the information most relevant to you.

Keysight Infoline

Keysight Infoline

www.keysight.com/find/Infoline

Keysight's insight to best in class information management. Free access to your Keysight equipment company reports and e-library.

KEYSIGHT SERVICES

Keysight Services

www.keysight.com/find/services

Our deep offering in design, test, and measurement services deploys an industry-leading array of people, processes, and tools. The result? We help you implement new technologies and engineer improved processes that lower costs.



Three-Year Warranty

www.keysight.com/find/ThreeYearWarranty

Keysight's committed to superior product quality and lower total cost of ownership. Keysight is the only test and measurement company with three-year warranty standard on all instruments, worldwide. And, we provide a one-year warranty on many accessories, calibration devices, systems and custom products.



Keysight Assurance Plans

www.keysight.com/find/AssurancePlans

Up to ten years of protection and no budgetary surprises to ensure your instruments are operating to specification, so you can rely on accurate measurements.

Keysight Channel Partners

www.keysight.com/find/channelpartners

Get the best of both worlds: Keysight's measurement expertise and product breadth, combined with channel partner convenience.

www.keysight.com/find/pna
www.keysight.com/find/8510
www.keysight.com/find/ecal

For more information on Keysight Technologies' products, applications or services, please contact your local Keysight office. The complete list is available at: www.keysight.com/find/contactus

Americas

Canada	(877) 894 4414
Brazil	55 11 3351 7010
Mexico	001 800 254 2440
United States	(800) 829 4444

Asia Pacific

Australia	1 800 629 485
China	800 810 0189
Hong Kong	800 938 693
India	1 800 11 2626
Japan	0120 (421) 345
Korea	080 769 0800
Malaysia	1 800 888 848
Singapore	1 800 375 8100
Taiwan	0800 047 866
Other AP Countries	(65) 6375 8100

Europe & Middle East

Austria	0800 001122
Belgium	0800 58580
Finland	0800 523252
France	0805 980333
Germany	0800 6270999
Ireland	1800 832700
Israel	1 809 343051
Italy	800 599100
Luxembourg	+32 800 58580
Netherlands	0800 0233200
Russia	8800 5009286
Spain	800 000154
Sweden	0200 882255
Switzerland	0800 805353
	Opt. 1 (DE)
	Opt. 2 (FR)
	Opt. 3 (IT)
United Kingdom	0800 0260637

For other unlisted countries:
www.keysight.com/find/contactus
 (BP-06-08-16)



www.keysight.com/go/quality
 Keysight Technologies, Inc.
 DEKRA Certified ISO 9001:2015
 Quality Management System